

SAW Bandpass Filter F4256



Features

- RF bandpass filter
- High attenuation
- Usable bandwidth 6MHz
- No matching 50Ω single-ended operation
- Ceramic Surface Mounted Device (SMD) Package

Package Dimensions

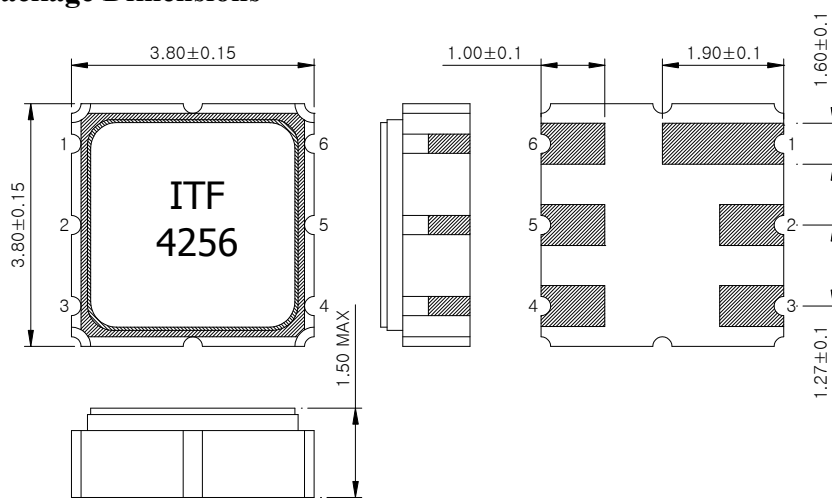

Dimensions shown are nominal in millimeters

Body : Al_2O_3 Ceramic

Lid : Kovar, Ni Plated

Terminations : Au plating $0.3 \sim 1.0$ μ m, Over a $1.27 \sim 8.89$ μ m Ni Plating

Pin Configuration	
2	Input
5	Output
1, 3, 4, 6	Case ground

Maximum Ratings

Parameter	Unit	Minimum	Typical	Maximum
Operating Temperature Range	°C	-10	25	60
Storage Temperature Range	°C	-40	-	85
Power Handling Capability	dBm	-	-	-

Electrostatics Sensitive Device (ESD)

	ITF Co., Ltd. 102-901, Bucheon Technopark 364, Samjeong-Dong, Ojeong-Gu, Bucheon-City, Gyeonggi-Do, Korea 421-809	Part No.	F4256	
		Rev. Date	2014-12-08	
		Rev.	NS3008-AS03	1/7

SAW Bandpass Filter F4256



Specifications

Fc = 425.0MHz

Terminating source impedance : 50Ω

Terminating load impedance : 50Ω

		Minimum	Typical	Maximum
Center Frequency (Fc)	MHz	-	425.0	-
Insertion Loss (Fc +/- 3.0 MHz)	dB	-	3.0	4.0
Amplitude Ripple (Fc +/- 3.0 MHz)	dB	-	1.0	2.0
Absolute Group Delay at Fc	nsec	-	120	-
Group Delay Variation (Fc +/- 3.0 MHz)	nsec	-	50	-
VSWR (Fc +/- 3.0 MHz)		-	1.5	2.0
Relative Attenuation 375.0 MHz ~ 410.0 MHz 450.0 MHz ~ 475.0 MHz	dB	45 45	50 50	-
Temperature Coefficient of Frequency	ppm/°C	-	-32	-

Notes :

- 1) All specifications are based on the matching schematic shown below, measured by Agilent Network analyzer and full 2 port calibration.
- 2) Electrical margin has been built into the design to account for the variations due to temperature drift and manufacturing tolerances
- 3) All attenuation measurements are measured relative to insertion loss

	ITF Co., Ltd. 102-901, Bucheon Technopark 364, Samjeong-Dong, Ojeong-Gu, Bucheon-City, Gyeonggi-Do, Korea 421-809	Part No.	F4256	
		Rev. Date	2014-12-08	
		Rev.	NS3008-AS03	2/7

SAW Bandpass Filter F4256



Matching Schematic

(Actual matching values may vary due to PCB layout and parasitics)

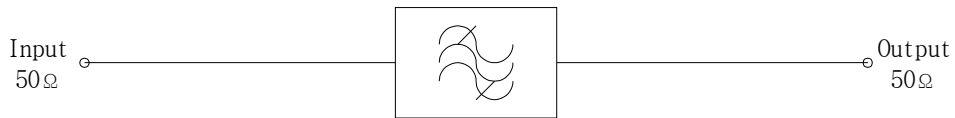

Marking Configuration

ITF¹⁾
4256²⁾

1) Manufacturer name

2) Marking Number

* Ink or Laser Marking available

 Integrated Technology Future	ITF Co., Ltd. 102-901, Bucheon Technopark 364, Samjeong-Dong, Ojeong-Gu, Bucheon-City, Gyeonggi-Do, Korea 421-809	Part No.	F4256	
		Rev. Date	2014-12-08	
		Rev.	NS3008-AS03	3/7

SAW Bandpass Filter F4256



Typical Performance (at 25°C)

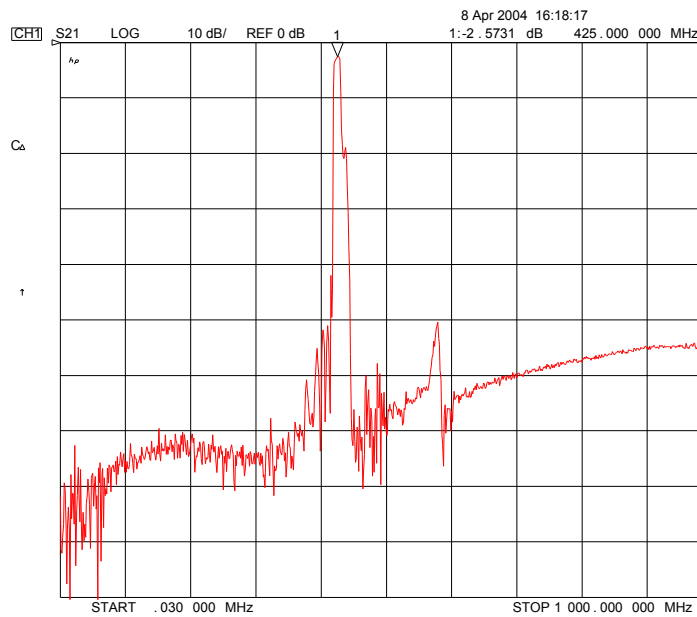
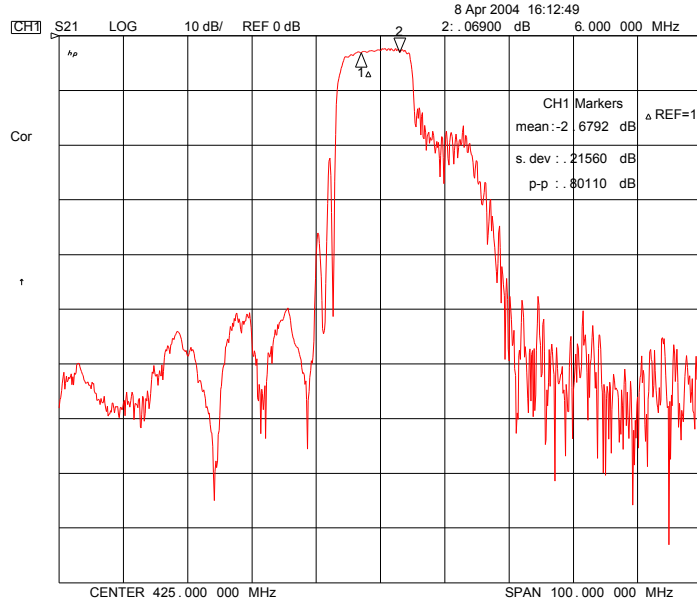

	ITF Co., Ltd. 102-901, Bucheon Technopark 364, Samjeong-Dong, Ojeong-Gu, Bucheon-City, Gyeonggi-Do, Korea 421-809	Part No.	F4256	
		Rev. Date	2014-12-08	
		Rev.	NS3008-AS03	4/7

SAW Bandpass Filter F4256



Input / Output VSWR Charts

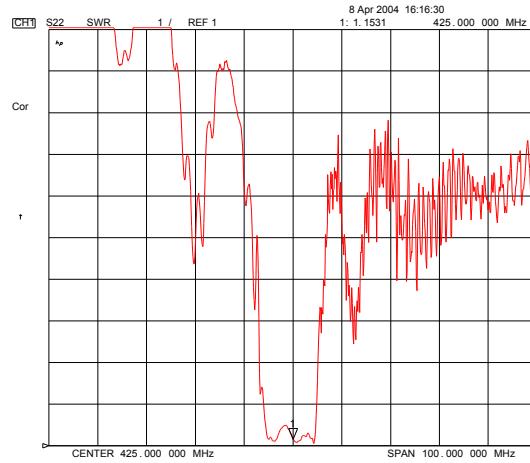
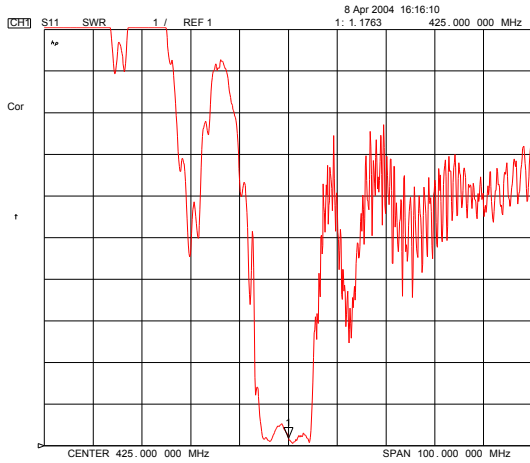

Input / Output Smith Charts

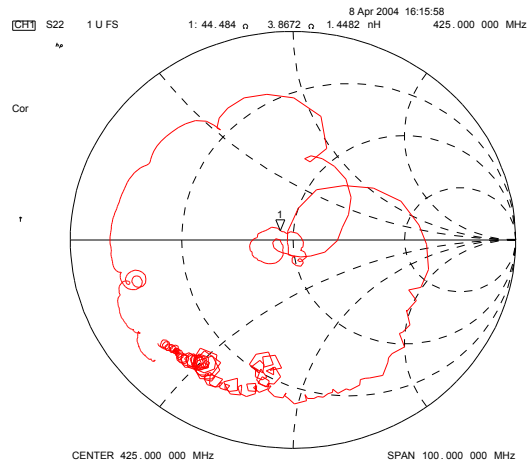
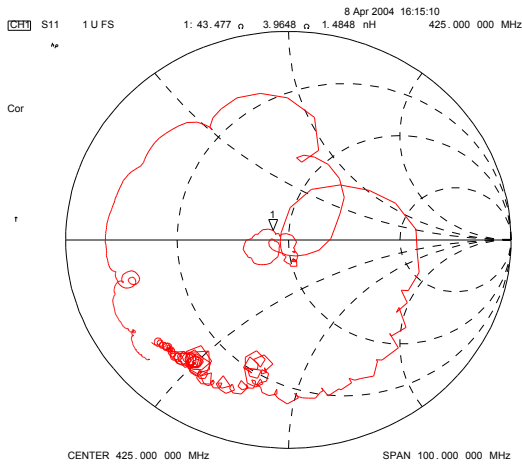

	ITF Co., Ltd. 102-901, Bucheon Technopark 364, Samjeong-Dong, Ojeong-Gu, Bucheon-City, Gyeonggi-Do, Korea 421-809	Part No.	F4256	
		Rev. Date	2014-12-08	
		Rev.	NS3008-AS03	5/7

SAW Bandpass Filter F4256



Packing Specification

1. Reeling Quantity : 1000 pcs / reel
2. Taping Structure : The tape shall be wound around the reel in the direction shown below.

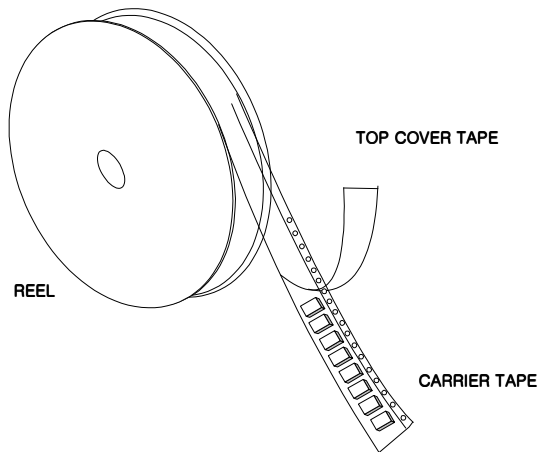

Tape Specification

1. Leader part and vacant position specification

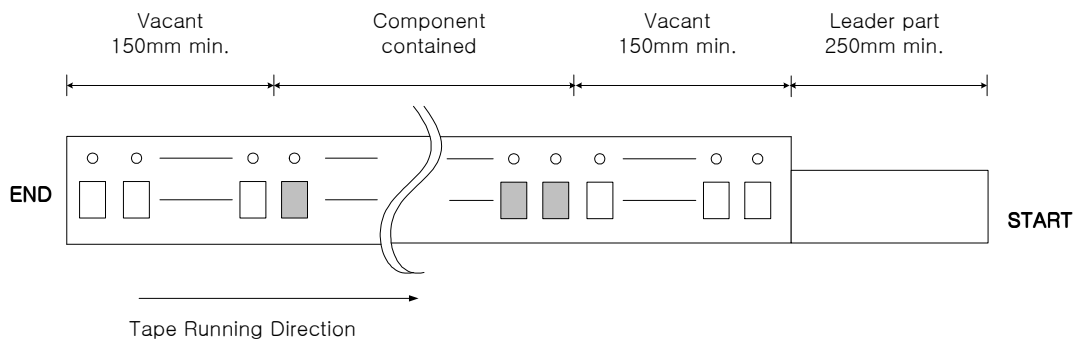

2. Tensile strength of carrier tape

4.4N/mm width

3. Top cover tape adhesion

- 1) pull off angle : 0~15°
- 2) speed : 300mm/min
- 3) force : 20~70g

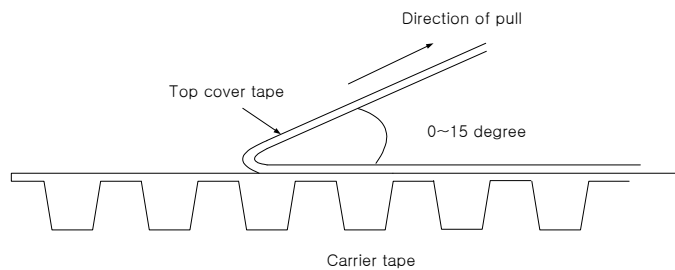

	ITF Co., Ltd. 102-901, Bucheon Technopark 364, Samjeong-Dong, Ojeong-Gu, Bucheon-City, Gyeonggi-Do, Korea 421-809	Part No.	F4256	
		Rev. Date	2014-12-08	
		Rev.	NS3008-AS03	6/7

SAW Bandpass Filter F4256



Carrier Tape Dimensions [unit : mm]

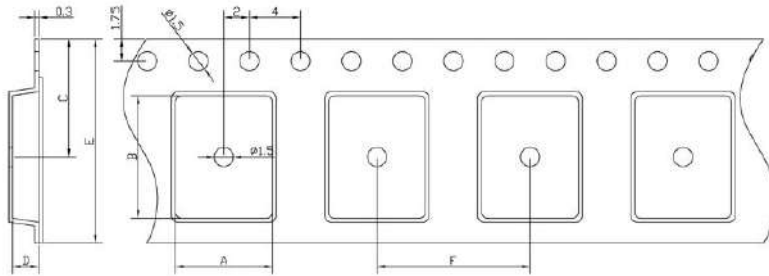

A	4.30 ± 0.1
B	4.30 ± 0.1
C	7.25 ± 0.1
D	1.70 ± 0.1
E	12.00 ± 0.1
F	8.00 ± 0.1

Part Direction

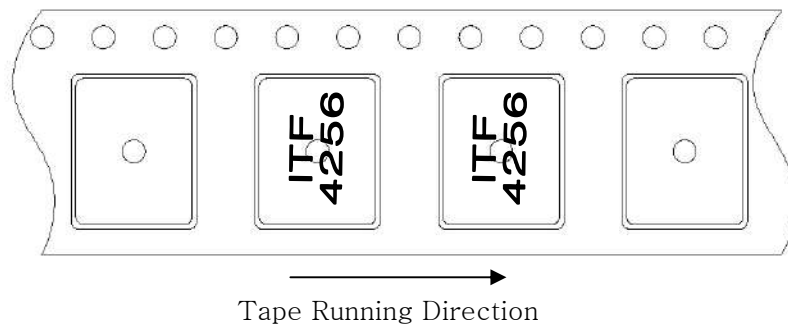

Reel Dimensions [unit : mm]

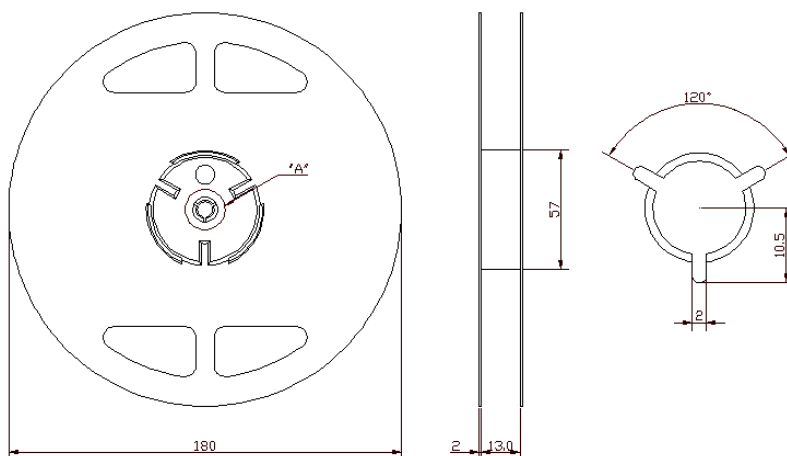

	ITF Co., Ltd. 102-901, Bucheon Technopark 364, Samjeong-Dong, Ojeong-Gu, Bucheon-City, Gyeonggi-Do, Korea 421-809	Part No.	F4256	
		Rev. Date	2014-12-08	
		Rev.	NS3008-AS03	7/7